

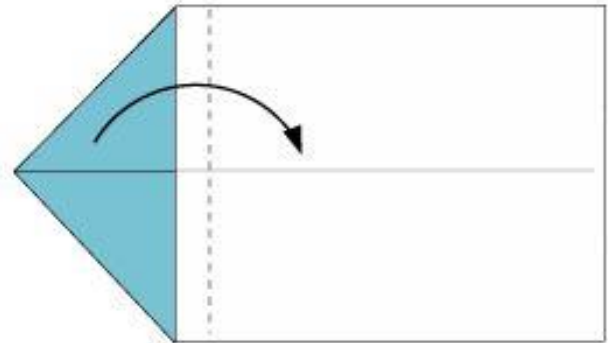

1 Fold in the dotted line to meet the center line

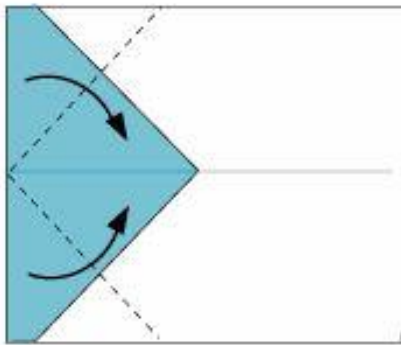

2 Fold in the dotted line



3 Fold in the dotted line to meet the center line

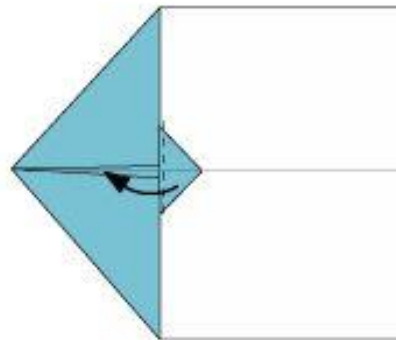

4 Fold in the dotted line

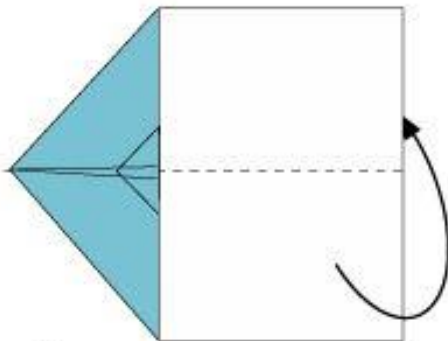

5 Fold backward in the dotted line

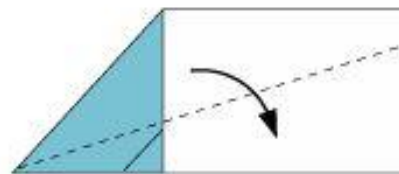

6 Fold in the dotted line

7 Finished

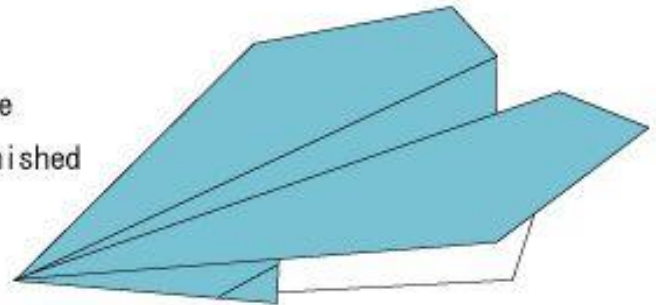

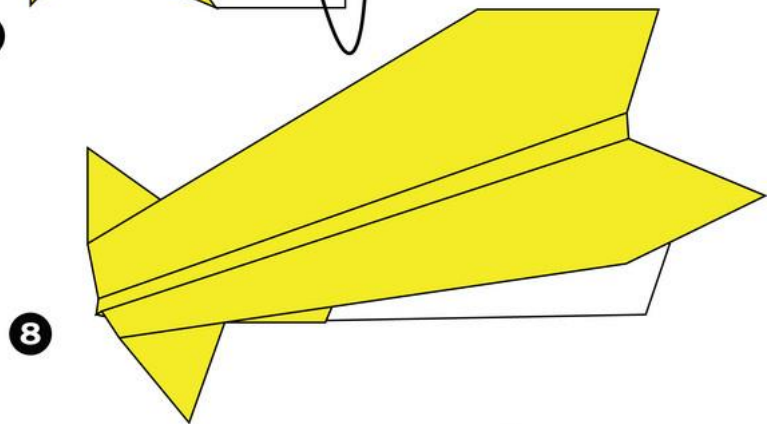
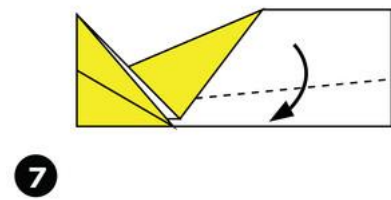
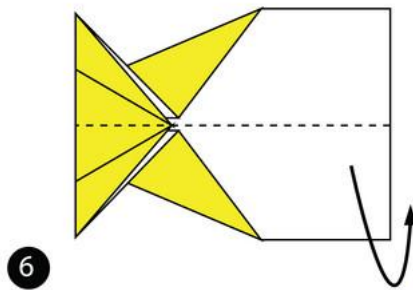
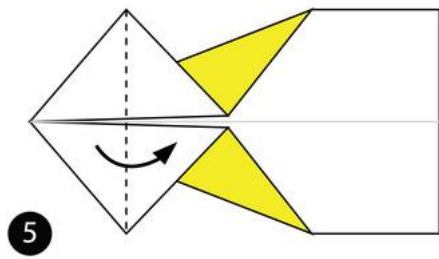
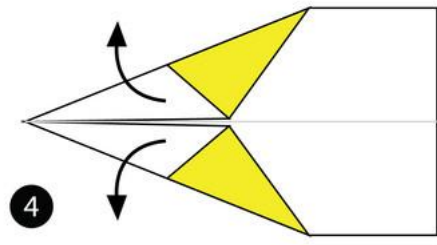
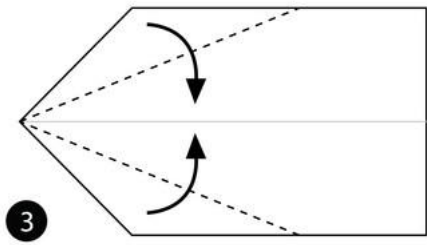
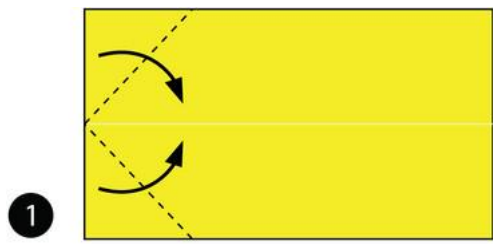

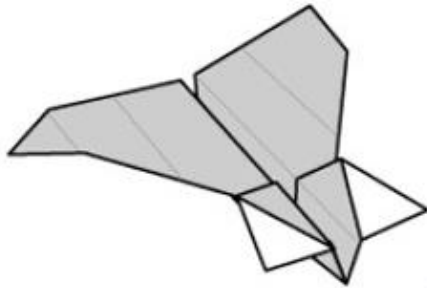
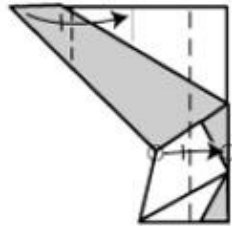
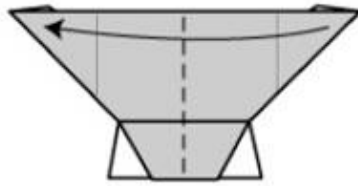
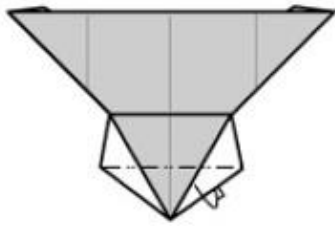
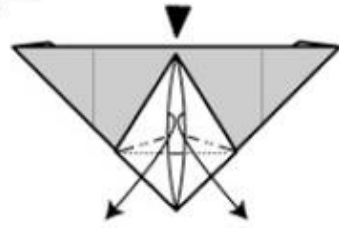
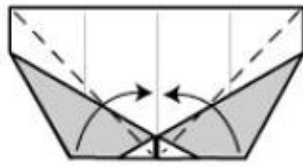
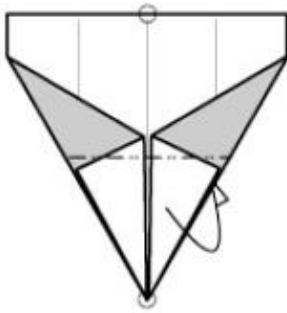
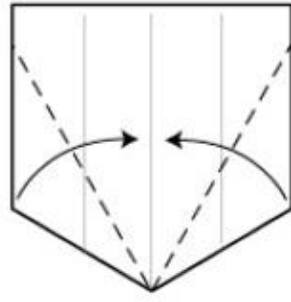
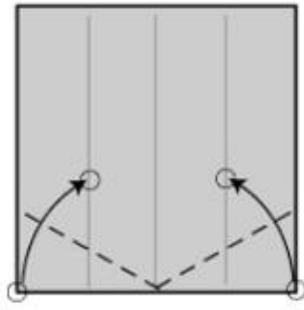
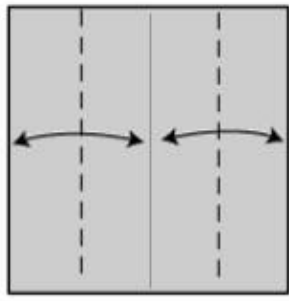

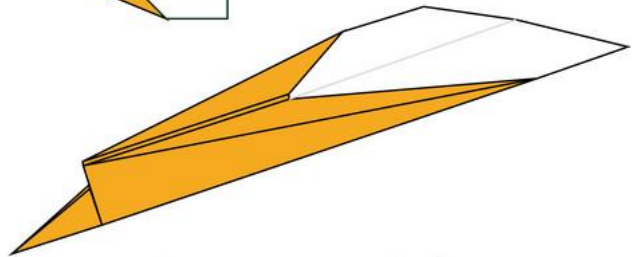
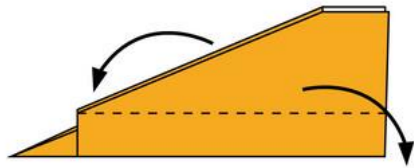
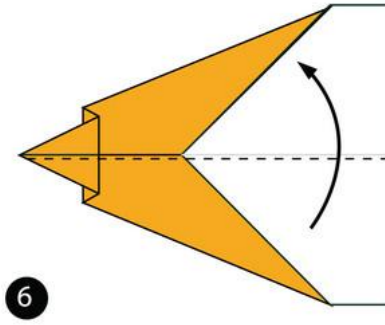
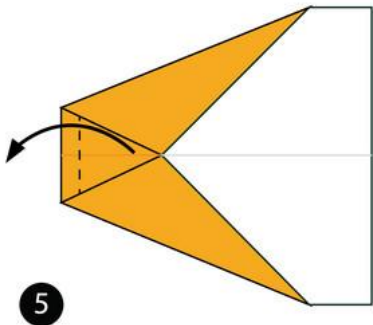
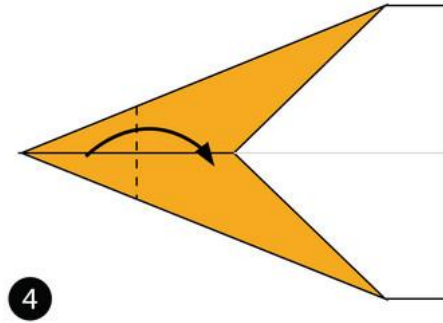
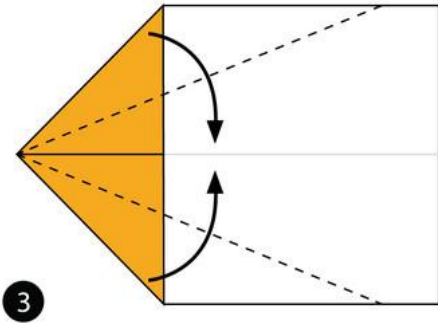
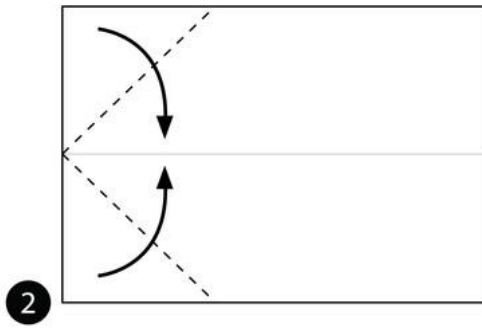
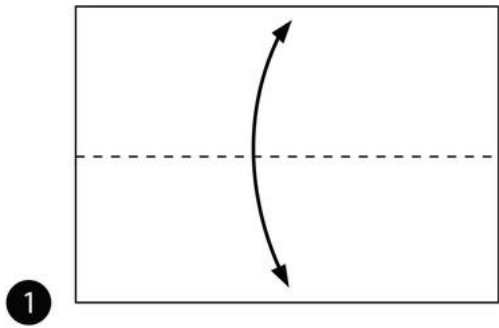

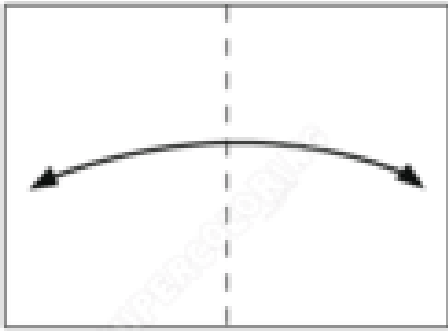

1

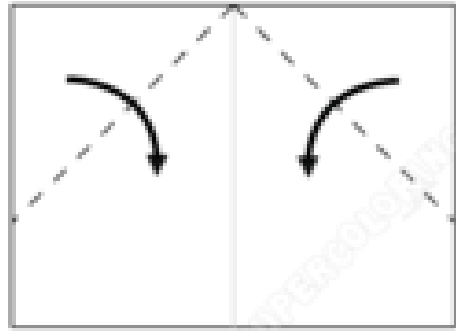

2

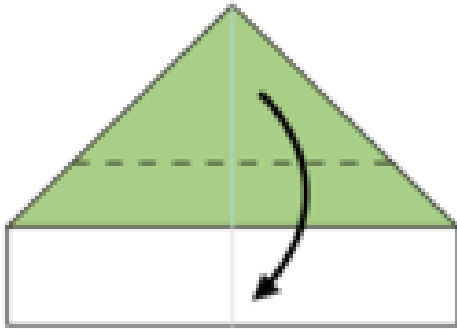

3

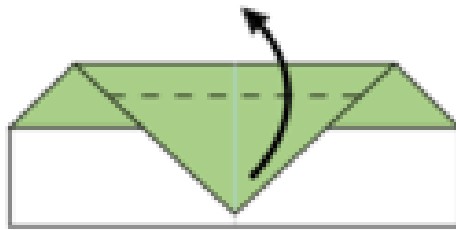

4

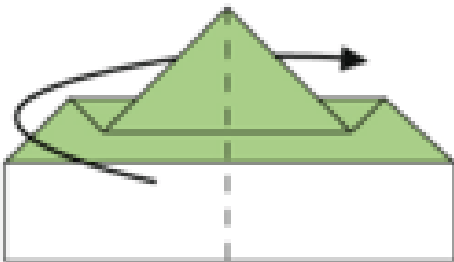

5

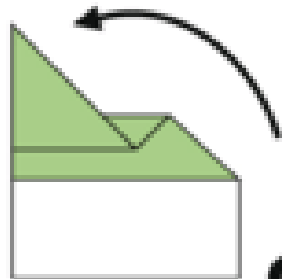

6

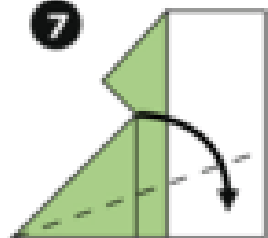

7

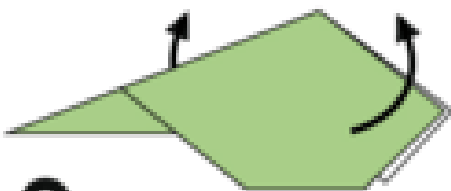

8



9

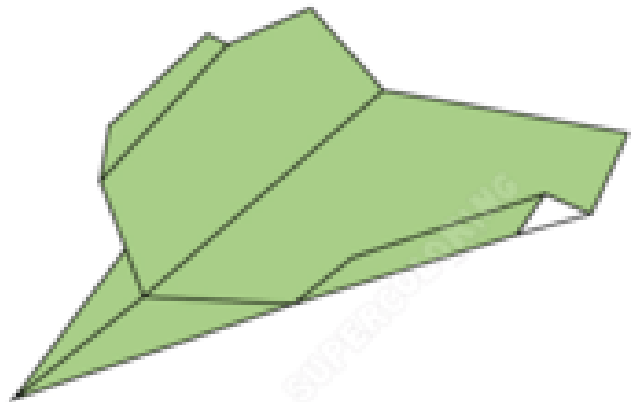

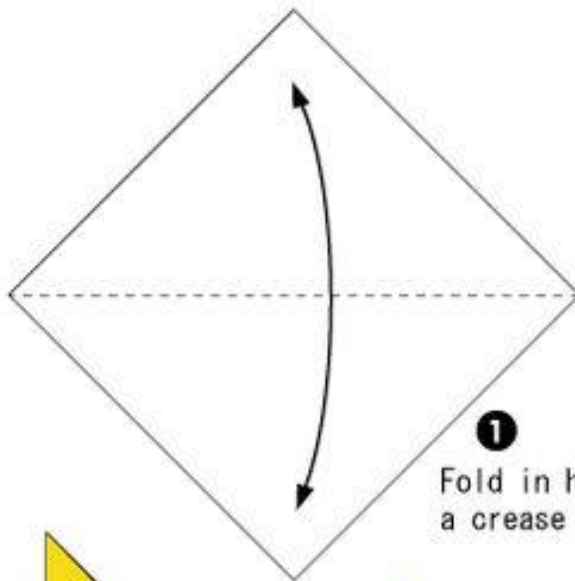

1
Fold in half to make
a crease and fold back

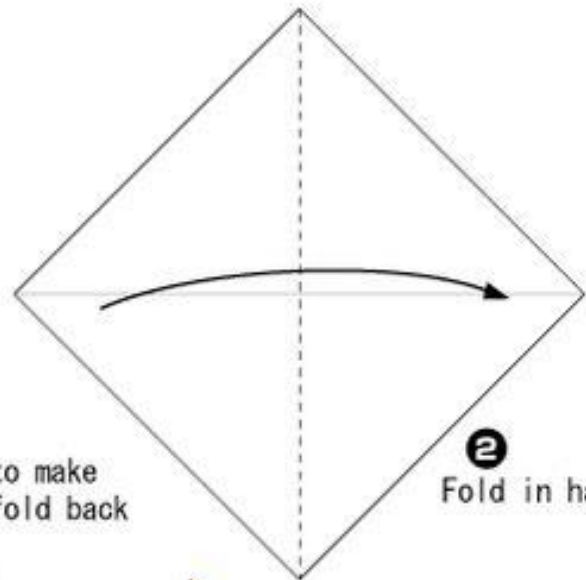

2
Fold in half

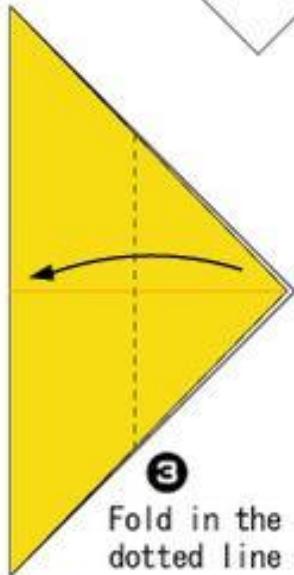

3
Fold in the
dotted line

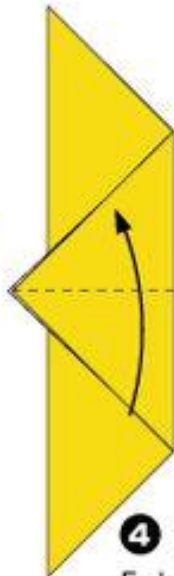

4
Fold in half

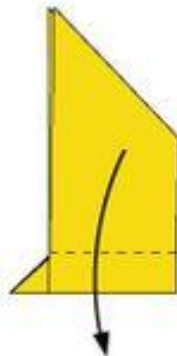

5 Fold in the
dotted line

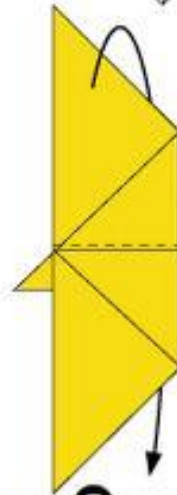

6
Fold in the
dotted line



7
Even up the wings



*Drop it

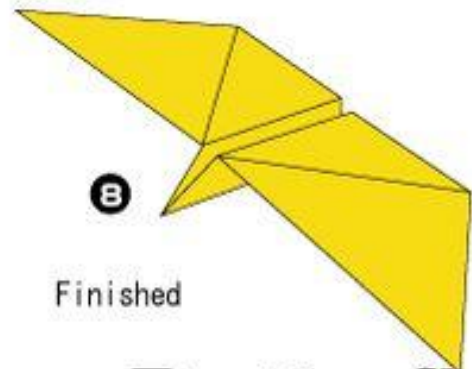

8
Finished

*Traditional
Diagram: Fumiaki Shingu

A Flapping Butterfly

Fold up

After folding



Top view

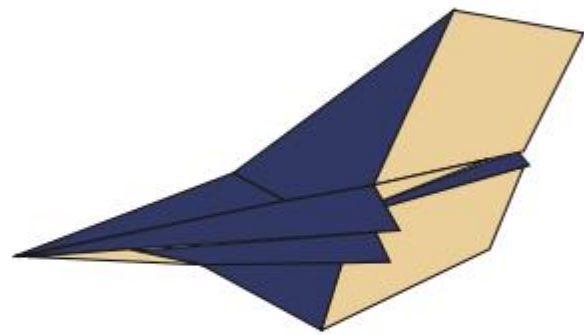

Completed

Glider Supreme



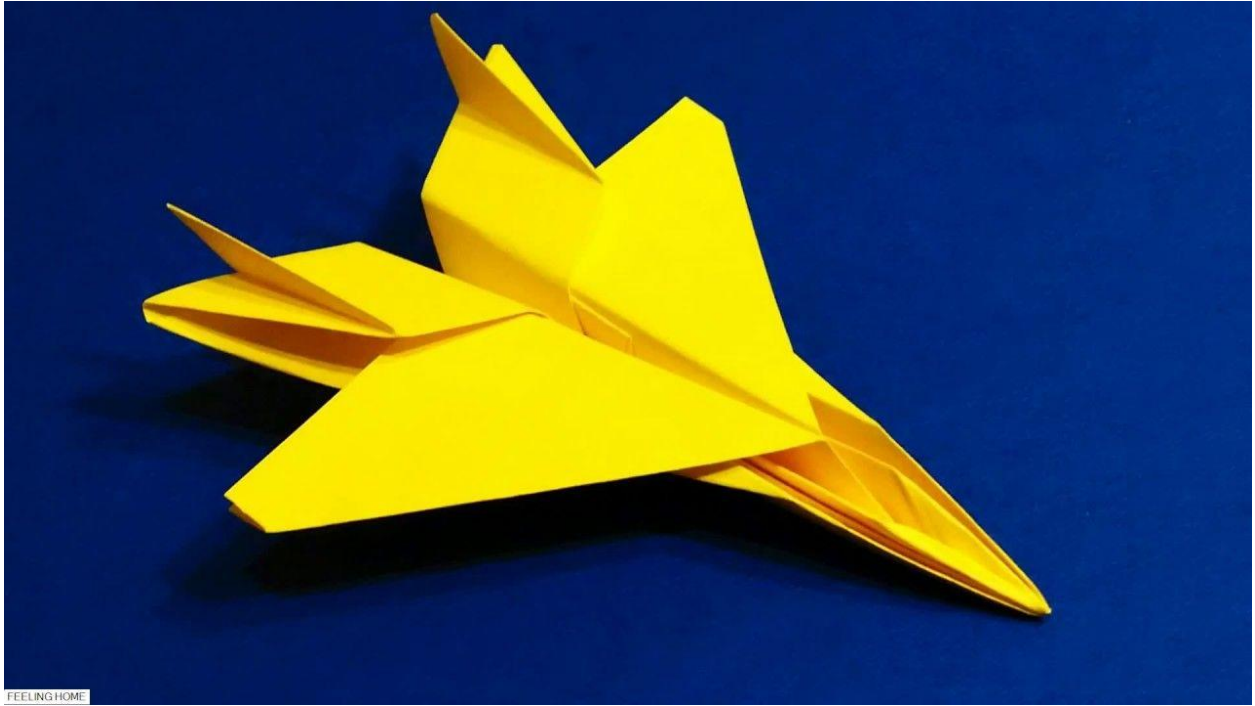

FEELING HOME

